

My yellow Book of all things

YELLOW!

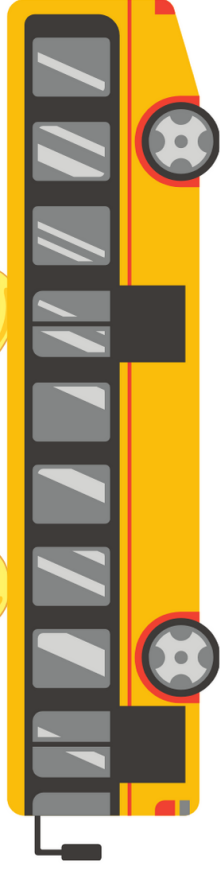
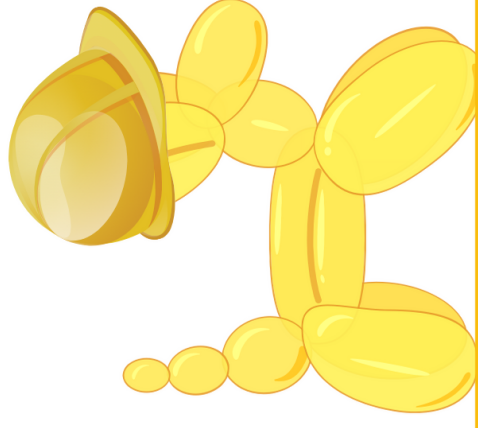

[alifyasinspirations](http://alifyasinspirations.com)

Bananas are YELLOW

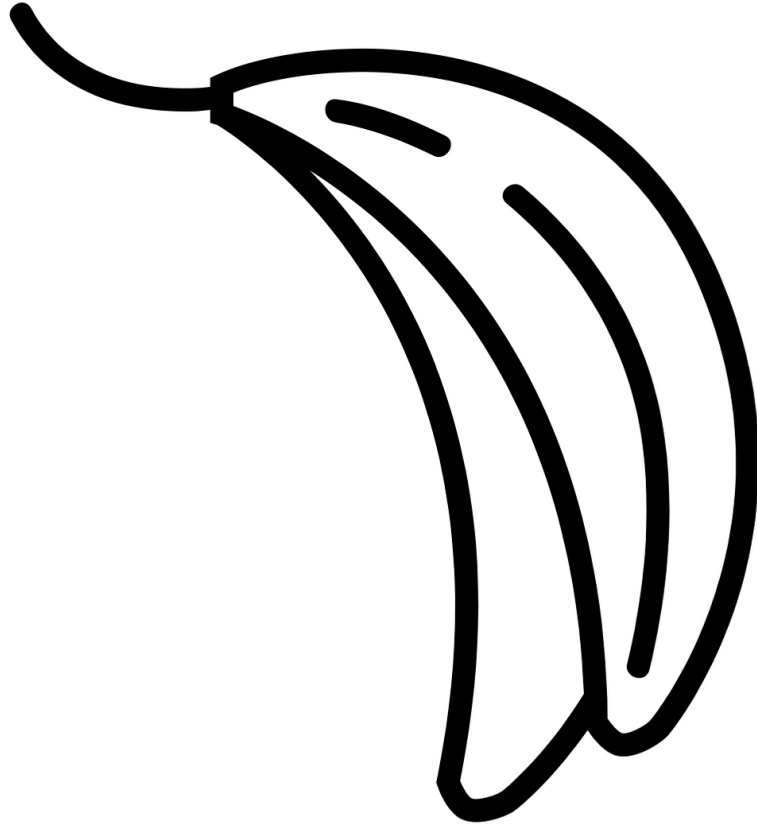

And so is a Lemon

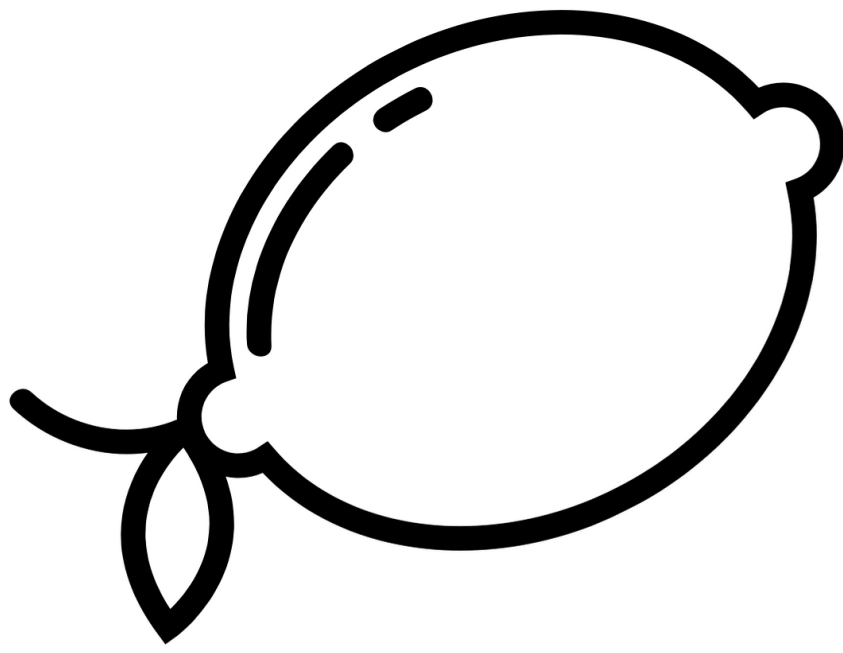

1

2

3

A hard hat is YELLOW

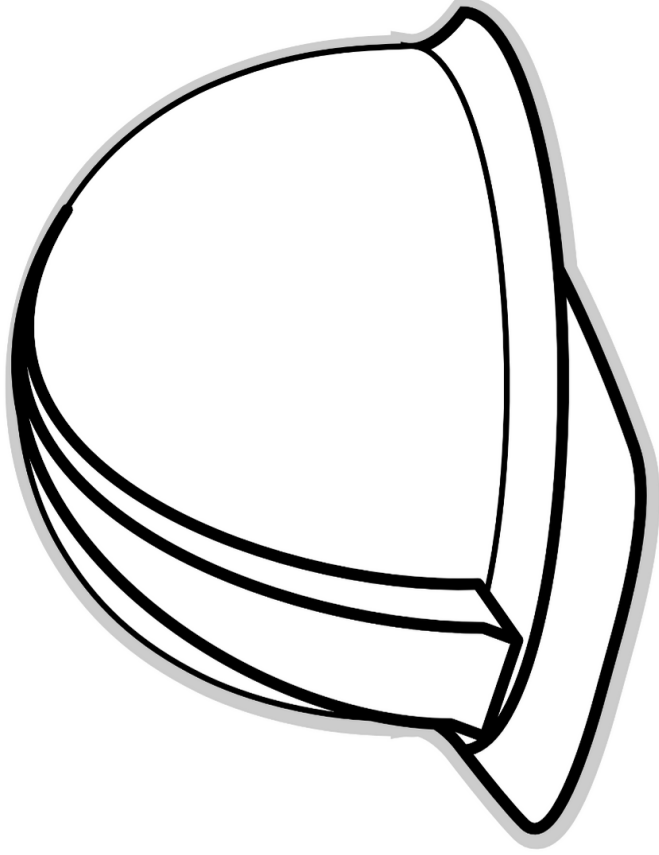

4

And so is an Excavator

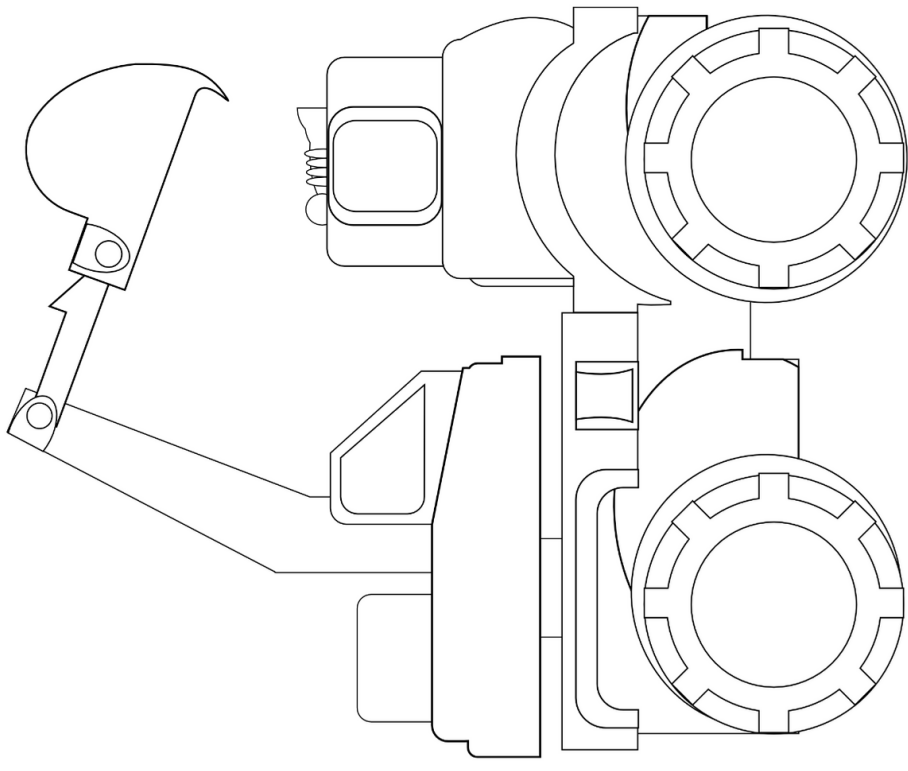

5

Sun is YELLOW

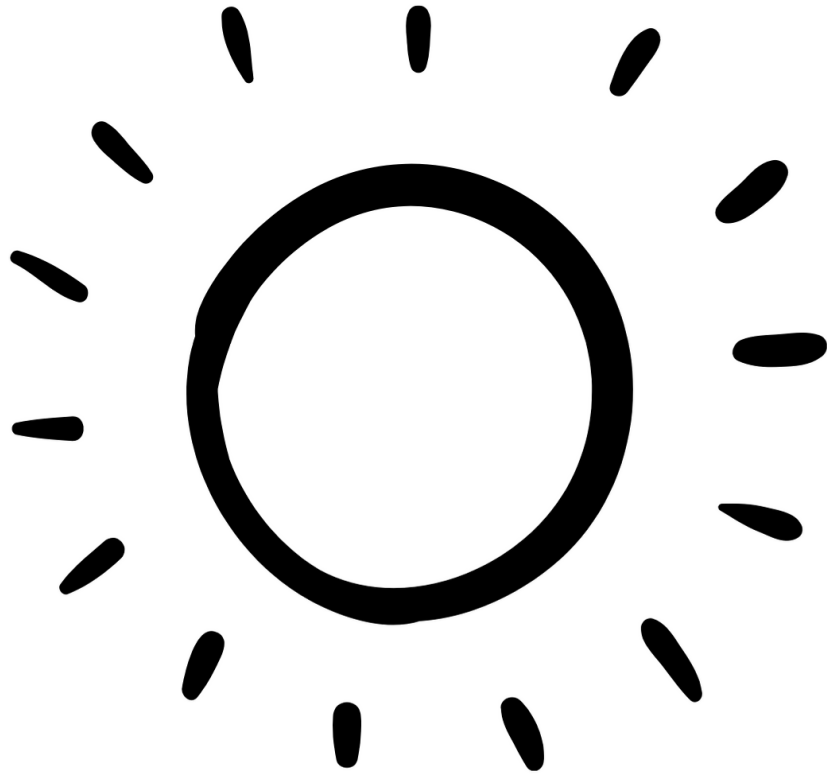

6

And so is a sunflower

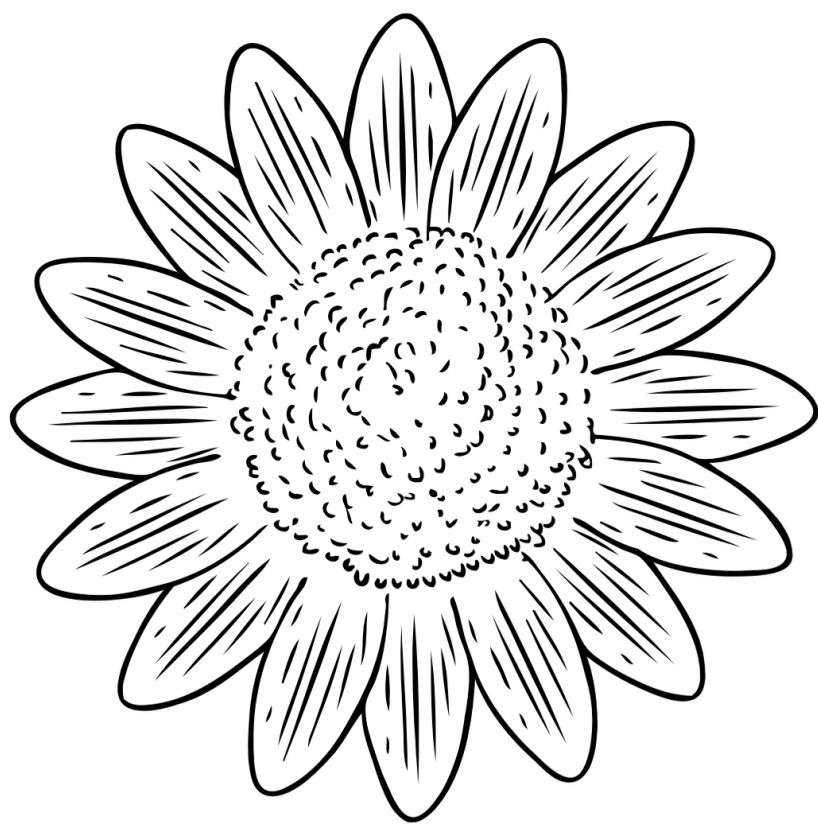

French Fries are
YELLOW

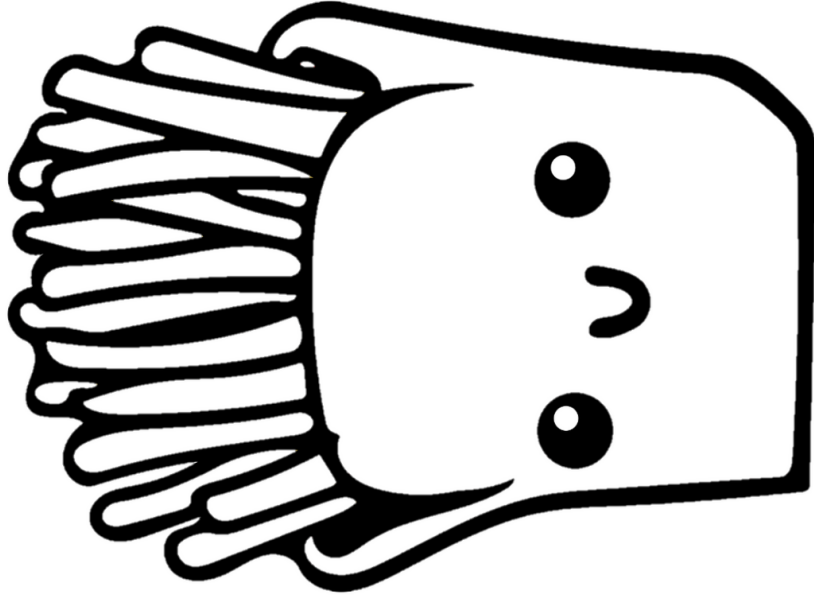

And so are corns

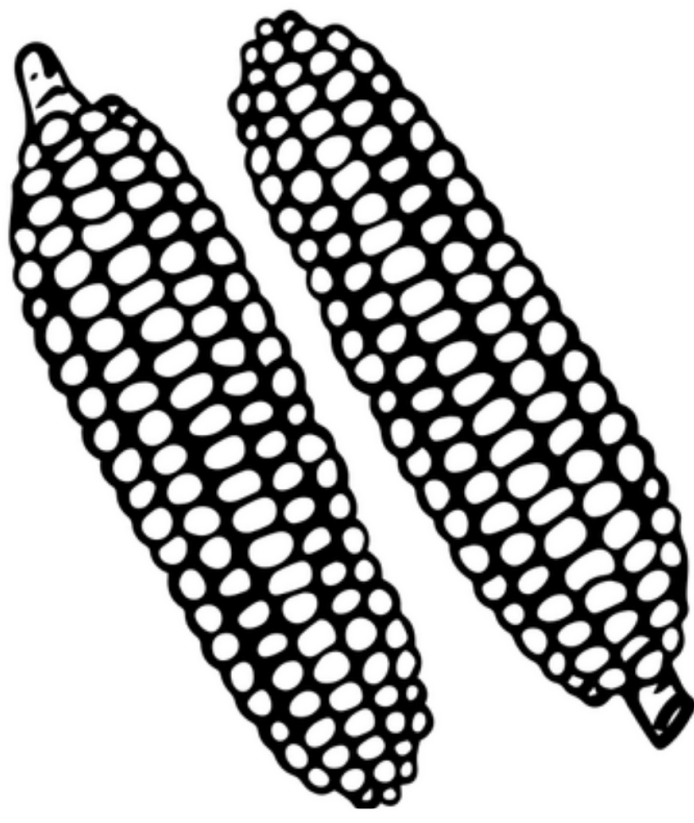

7

8

9

Now paste a piece of
YELLOW paper or
cloth in the box below:

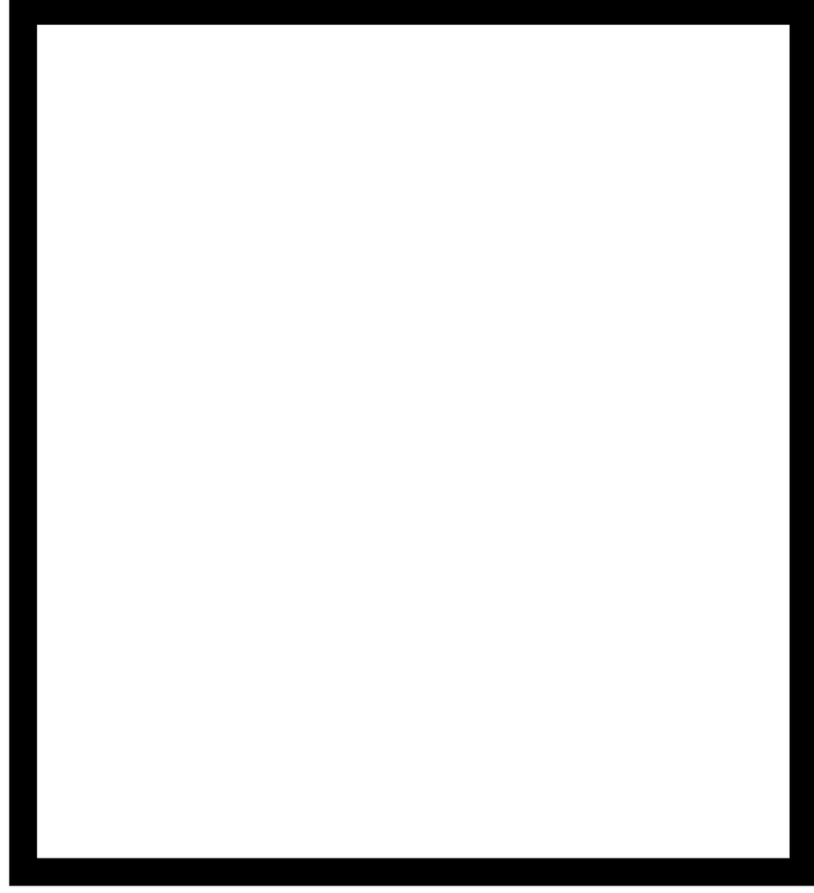

10

Let's find and draw
something YELLOW now:

